

PRODUCT DESCRIPTION

SPECTEC's gear actuated Zero Speed/Position Sensors are designed to switch in the presence of ferrous targets such as gear teeth and blade tips etc. Gear teeth as small as module 0.5 or 48 DP can be sensed.

The standard output is NPN Supply Tracking 0-Vs, provided from a 3k Ohm internal pull-up resistor to a collector, which can sink 25 mA. The output is normally high with no target present. Other output signal options are available; please see Page 2 for details.

SPECIFICATIONS

Vs, Supply Voltage:	4.0 to 30 VDC at ≤ 18 mA No Reverse Polarity Protection
Vo, Signal Out:	Output signal is typically 'Normally High', except for PNP output which is 'Normally Low'
Operating Freq.:	0 to ~20 kHz
Air Gap:	24 DP / Module 1: .040" (1.0mm) 12 DP / Module 2: .060" (1.5mm) 5 DP / Module 5: .120" (3.0mm)
Magnetization:	Standard: -1500 Gauss Low Mag: -500 Gauss
Rise/Fall Time:	0.10 μs to 2 μs *Dependent on Configuration
Temperature Range:	2TE: -40° to 221°F (-40° to 105°C) *May be reduced based on configuration 3TE: -40° to 300°F (-40° to 150°C) *May be reduced based on configuration
Transmit Distance:	1500' (~500m) max.
Construction:	300 Series Stainless Steel Housing Solid Encapsulation
Connectors & Pin Assignments:	See Page 2 All have gold plated contacts
Lead Wire Assignments:	2TE: PVC 26-28 AWG (105°C) 3TE: TFE 26-28 AWG (150°C) Red: Supply (+) Black: Common (-) White/Green: Signal Out Bare: Cable Shielding

CE-Compliance: EN55011, EN50082-2

OPTIONS

Custom configurations, thread sizes (including metric), special materials of construction, special output circuits (including short circuit protection), and temperature probes (NTC10, RTD100, or others positioned near the face of the sensor) are also available.

0165K 1/4-40 UNS
0165KB 1/4-28 UNF
0165KM M6 x 0.75

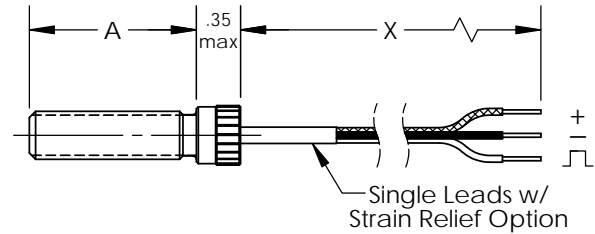

0165H 1/4-40 UNS
0165HB 1/4-28 UNF
0165HM M6 x 0.75

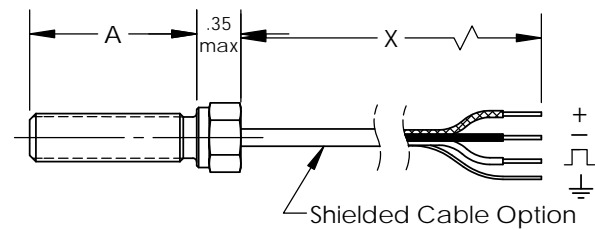

0165A 1/4-40 UNS
0165AB 1/4-28 UNF
0165AM M6 x 0.75
0165AM8 M8 x 1.0

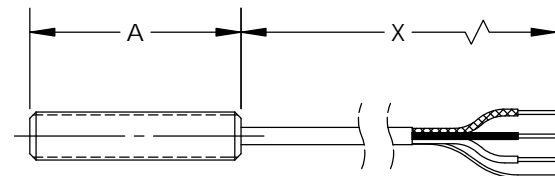

0165S Ø1/4 (6.4 mm) Smooth
0165S8 Ø5/16 (8.0 mm) Smooth

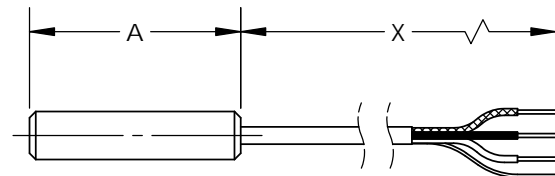

0165 1/4-40 UNS
0165B 1/4-28 UNF
0165M M6 x 0.75

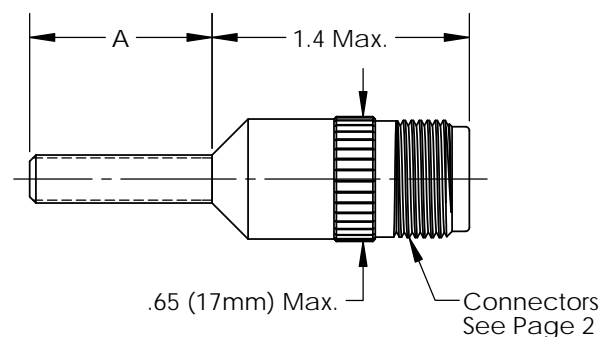

ORDER INFORMATION

Style	Options	Threads/Dia.
0165K	- <input type="checkbox"/> <input type="checkbox"/> <input type="checkbox"/> <input type="checkbox"/> <input type="checkbox"/>	1/4-40 UNS
0165KB	- <input type="checkbox"/> <input type="checkbox"/> <input type="checkbox"/> <input type="checkbox"/> <input type="checkbox"/>	1/4-28 UNF
0165KM	- <input type="checkbox"/> <input type="checkbox"/> <input type="checkbox"/> <input type="checkbox"/> <input type="checkbox"/>	M6x0.75
0165H	- <input type="checkbox"/> <input type="checkbox"/> <input type="checkbox"/> <input type="checkbox"/> <input type="checkbox"/>	1/4-40 UNS
0165HB	- <input type="checkbox"/> <input type="checkbox"/> <input type="checkbox"/> <input type="checkbox"/> <input type="checkbox"/>	1/4-28 UNF
0165HM	- <input type="checkbox"/> <input type="checkbox"/> <input type="checkbox"/> <input type="checkbox"/> <input type="checkbox"/>	M6x0.75
0165A	- <input type="checkbox"/> <input type="checkbox"/> <input type="checkbox"/> <input type="checkbox"/> <input type="checkbox"/>	1/4-40 UNS
0165AB	- <input type="checkbox"/> <input type="checkbox"/> <input type="checkbox"/> <input type="checkbox"/> <input type="checkbox"/>	1/4-28 UNF
0165AM	- <input type="checkbox"/> <input type="checkbox"/> <input type="checkbox"/> <input type="checkbox"/> <input type="checkbox"/>	M6x0.75
0165AM8	- <input type="checkbox"/> <input type="checkbox"/> <input type="checkbox"/> <input type="checkbox"/> <input type="checkbox"/>	M8x1.0
0165S	- <input type="checkbox"/> <input type="checkbox"/> <input type="checkbox"/> <input type="checkbox"/> <input type="checkbox"/>	1/4" Smooth
0165S8	- <input type="checkbox"/> <input type="checkbox"/> <input type="checkbox"/> <input type="checkbox"/> <input type="checkbox"/>	5/16" Smooth
Thread Length(A):		0 - .75" (19mm) 1 - 1.0" (25mm) 2 - 1.5" (38mm) 3 - 2.0" (50mm) 4 - 3.0" (75mm)
Temperature Range:		0 - 2TE: -40° to 221°F (-40° to 105°C) 5 - 3TE: -40° to 302°F (-40° to 150°C)
Vo, Signal Out:		1 - 0-Vs, NPN w/internal 3k Ohms pull-up [Normally High] 2 - 0-Vs, NPN OC (Open Collector) [Normally High] 3 - 0-Vs, PNP OC [Normally Low] 5 - 0-5V, NPN (TTL) [Normally High]
Sensor Type:		3 - Standard Mag (~+1500 Gauss)
Lead Wire(X):	2 - 2' (0.6m) Single Leads 7 - 3' (1.0m) Shielded Cable 9 - 10' (3.0m) Shielded Cable	(Shield NOT connect to sensors shell, shield is intended to be connect to instrument panel ground.)

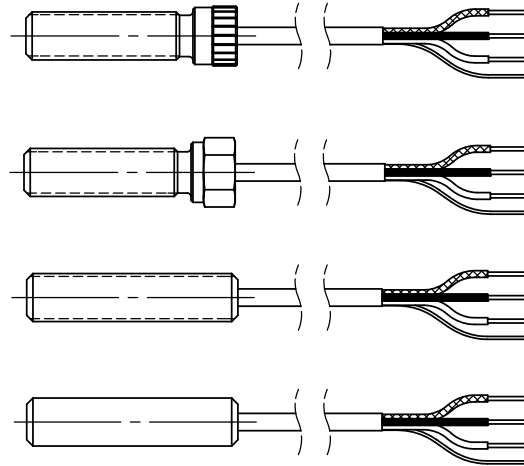

Above illustrations are shown with shielded cable.

0165	- <input type="checkbox"/> <input type="checkbox"/> <input type="checkbox"/> <input type="checkbox"/> <input type="checkbox"/>	1/4-40 UNS
0165B	- <input type="checkbox"/> <input type="checkbox"/> <input type="checkbox"/> <input type="checkbox"/> <input type="checkbox"/>	1/4-28 UNF
0165M	- <input type="checkbox"/> <input type="checkbox"/> <input type="checkbox"/> <input type="checkbox"/> <input type="checkbox"/>	M6x0.75

Thread Length(A):		1 - 1.0" (25mm) 2 - 1.5" (38mm) 3 - 2.0" (50mm) 4 - 3.0" (75mm)
-------------------	--	--

SAME AS ABOVE

Connector:	1 - MS3: 3 Pin MS3102-10SL-3P (see Bulletin 3000)
	2 - MC3: 3 Pin MICRO C (see Bulletin 3004)
	3 - MS3B: 3 Pin MS3102-10SL-3P (see Bulletin 3000)
	4 - B4: 4 Pin BAYONET MS3113-H8A4P (see Bulletin 3005)
	6 - MD4: 4 Pin MICRO DIN (see Bulletin 3005)

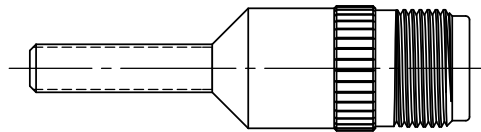

CONNECTOR PINOUTS

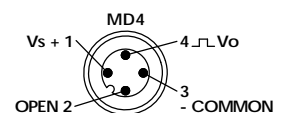
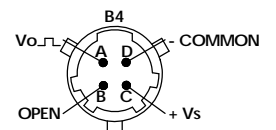
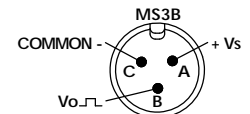
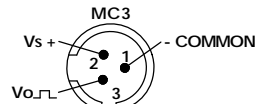
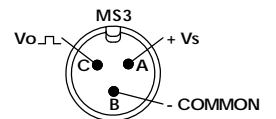

Note: The magnetization level for special or low mag sensors is designated as a suffix to the P/N, ie: 0165-11111-500G Designating a gauss level of 500±50. (Standard mag. level will NOT have a suffix)

A Normally Low output signal is available for the NPN output signal option (TTL, Supply Tracking and Open Collector) by adding '-NL' to the end of the part number.

Similarly, a Normally High output signal is available for the PNP output signal option by adding '-NH' to the end of the part number.